

**N-Channel Enhancement Mode Power MOSFET**

# MTB20N06FP

BV <sub>DSS</sub>	60V
I <sub>D</sub> @ V <sub>GS</sub> =10V, T <sub>C</sub> =25°C	27A
R <sub>DS(on)(TYP)</sub> @ V <sub>GS</sub> =10V, I <sub>D</sub> =20A	18.3mΩ
R <sub>DS(on)(TYP)</sub> @ V <sub>GS</sub> =4.5V, I <sub>D</sub> =20A	21.7mΩ

**Features**

- Low On Resistance
- Simple Drive Requirement
- Low Gate Charge
- Fast Switching Characteristic
- Insulating package, front/back side insulating voltage=2500V(AC)
- RoHS compliant package

**Symbol**

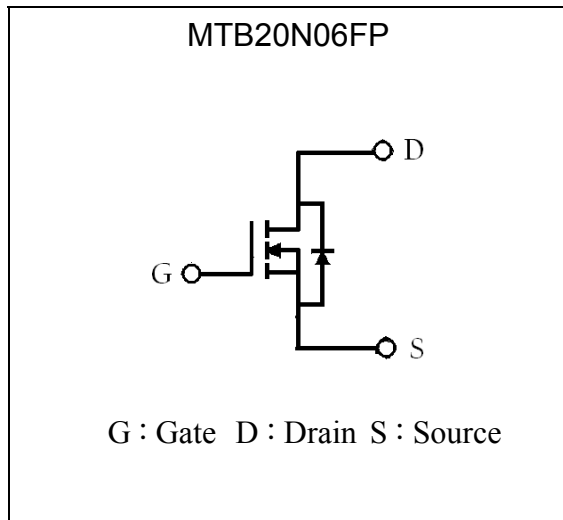

**Outline**

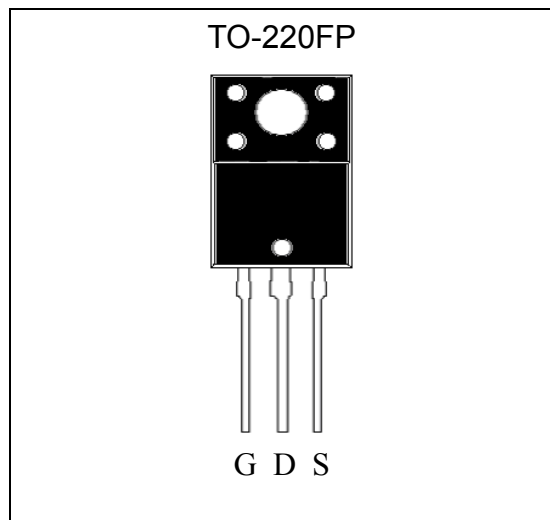

**Ordering Information**

Device	Package	Shipping
MTB20N06FP-0-UB-S	TO-220FP (RoHS compliant package)	50 pcs/tube, 20 tubes/box, 4 boxes / carton

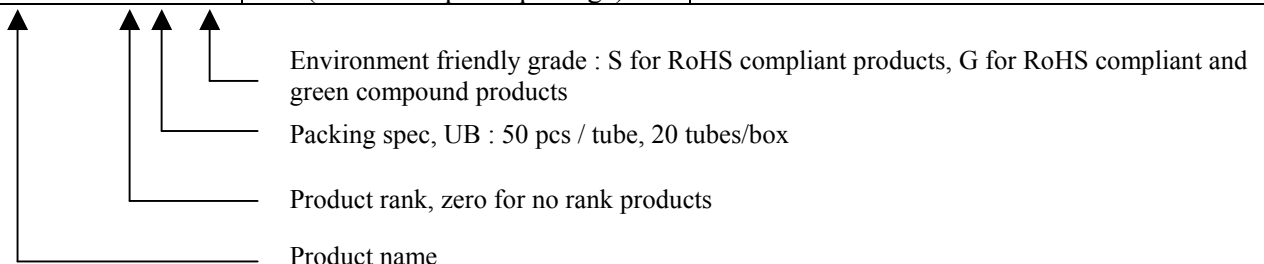

**Absolute Maximum Ratings** ( $T_C=25^{\circ}\text{C}$ , unless otherwise noted)

Parameter	Symbol	Limits	Unit	
Drain-Source Voltage	$V_{DS}$	60	V	
Gate-Source Voltage	$V_{GS}$	$\pm 20$		
Continuous Drain Current @ $T_C=25^{\circ}\text{C}$ , $V_{GS}=10\text{V}$	$I_D$	27	A	
Continuous Drain Current @ $T_C=100^{\circ}\text{C}$ , $V_{GS}=10\text{V}$		19		
Pulsed Drain Current (Note 3)	$I_{DM}$	108		
Continuous Drain Current @ $T_A=25^{\circ}\text{C}$ , $V_{GS}=10\text{V}$ (Note 2)	$I_{DSM}$	6.7		
Continuous Drain Current @ $T_A=70^{\circ}\text{C}$ , $V_{GS}=10\text{V}$ (Note 2)		5.4		
Avalanche Current (Note 3)	$I_{AS}$	17		
Avalanche Energy @ $L=1\text{mH}$ , $I_D=17\text{A}$ , $R_G=25\ \Omega$ (Note 2)	$E_{AS}$	144.5	mJ	
Repetitive Avalanche Energy @ $L=0.1\text{mH}$ (Note 3)	$E_{AR}$	4		
Power Dissipation	$T_C=25^{\circ}\text{C}$ (Note 1)	$P_D$	37.5	W
	$T_C=100^{\circ}\text{C}$ (Note 1)		18.7	
Power Dissipation	$T_A=25^{\circ}\text{C}$ (Note 2)	$P_{DSM}$	2	W
	$T_A=70^{\circ}\text{C}$ (Note 2)		1.3	
Operating Junction and Storage Temperature	$T_J, T_{stg}$	-55~+175	$^{\circ}\text{C}$	

**Thermal Data**

Parameter	Symbol	Value	Unit
Thermal Resistance, Junction-to-case, max	$R_{th,j-c}$	4	$^{\circ}\text{C}/\text{W}$
Thermal Resistance, Junction-to-ambient, max, $t \leq 10\text{s}$ (Note 2)	$R_{th,j-a}$	15	$^{\circ}\text{C}/\text{W}$
Thermal Resistance, Junction-to-ambient, max (Note 2)		62.5	$^{\circ}\text{C}/\text{W}$

- Note : 1. The power dissipation  $P_D$  is based on  $T_{J(MAX)}=175^{\circ}\text{C}$ , using junction-to-case thermal resistance, and is more useful in setting the upper dissipation limit for cases where additional heatsinking is used.
2. The value of  $R_{\theta JA}$  is measured with the device mounted on 1 in<sup>2</sup> FR-4 board with 2 oz. copper, in a still air environment with  $T_A=25^{\circ}\text{C}$ . The power dissipation  $P_{DSM}$  is based on  $R_{\theta JA}$  and the maximum allowed junction temperature of  $150^{\circ}\text{C}$ . The value in any given application depends on the user's specific board design, and the maximum temperature of  $175^{\circ}\text{C}$  may be used if the PCB allows it.
3. Repetitive rating, pulse width limited by junction temperature  $T_{J(MAX)}=175^{\circ}\text{C}$ . Ratings are based on low frequency and low duty cycles to keep initial  $T_J=25^{\circ}\text{C}$ .



**Characteristics (Tj=25°C, unless otherwise specified)**

Symbol	Min.	Typ.	Max.	Unit	Test Conditions
<b>Static</b>					
BV <sub>DSS</sub>	60	-	-	V	V <sub>GS</sub> =0V, I <sub>D</sub> =250μA
ΔBV <sub>DSS</sub> /ΔT <sub>j</sub>	-	0.06	-	V/°C	Reference to 25°C, I <sub>D</sub> =250μA
V <sub>GS(th)</sub>	1.0	-	2.5	V	V <sub>DS</sub> = V <sub>GS</sub> , I <sub>D</sub> =250μA
*G <sub>FS</sub>	-	25	-	S	V <sub>DS</sub> =5V, I <sub>D</sub> =20A
I <sub>GSS</sub>	-	-	±100	nA	V <sub>GS</sub> =±20V
I <sub>DSS</sub>	-	-	1	μA	V <sub>DS</sub> =48V, V <sub>GS</sub> =0V
	-	-	5		V <sub>DS</sub> =48V, V <sub>GS</sub> =0V, T <sub>j</sub> =55°C
*R <sub>DS(ON)</sub>	-	18.3	23	mΩ	V <sub>GS</sub> =10V, I <sub>D</sub> =20A
	-	21.7	28.5		V <sub>GS</sub> =4.5V, I <sub>D</sub> =10A
<b>Dynamic</b>					
*Q <sub>g</sub>	-	20.4	-	nC	V <sub>DS</sub> =48V, I <sub>D</sub> =27A, V <sub>GS</sub> =10V
*Q <sub>gs</sub>	-	1.3	-		
*Q <sub>gd</sub>	-	13.5	-		
*t <sub>d(ON)</sub>	-	10	-	ns	V <sub>DS</sub> =30V, I <sub>D</sub> =27A, V <sub>GS</sub> =10V, R <sub>G</sub> =3.3 Ω
*t <sub>r</sub>	-	15	-		
*t <sub>d(OFF)</sub>	-	28.6	-		
*t <sub>f</sub>	-	7.8	-		
C <sub>iss</sub>	-	1096	-	pF	V <sub>GS</sub> =0V, V <sub>DS</sub> =25V, f=1MHz
C <sub>oss</sub>	-	87	-		
C <sub>rss</sub>	-	44	-		
R <sub>g</sub>	-	2.7	-	Ω	f=1MHz
<b>Source-Drain Diode</b>					
*I <sub>S</sub>	-	-	27	A	
*I <sub>SM</sub>	-	-	108		
*V <sub>SD</sub>	-	0.71	1	V	I <sub>S</sub> =1A, V <sub>GS</sub> =0V
*t <sub>rr</sub>	-	13	-	ns	V <sub>GS</sub> =0V, I <sub>F</sub> =27A, dI/dt=100A/μs
*Q <sub>rr</sub>	-	7.8	-	nC	

\*Pulse Test : Pulse Width ≤300μs, Duty Cycle≤2%

**Typical Characteristics**

Typical Output Characteristics

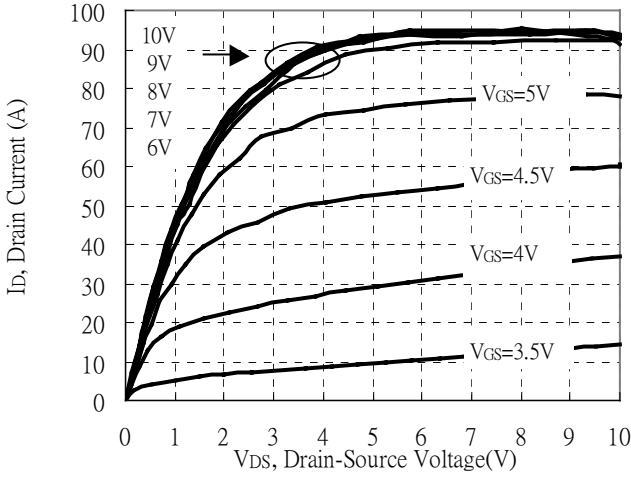

Brekdown Voltage vs Ambient Temperature

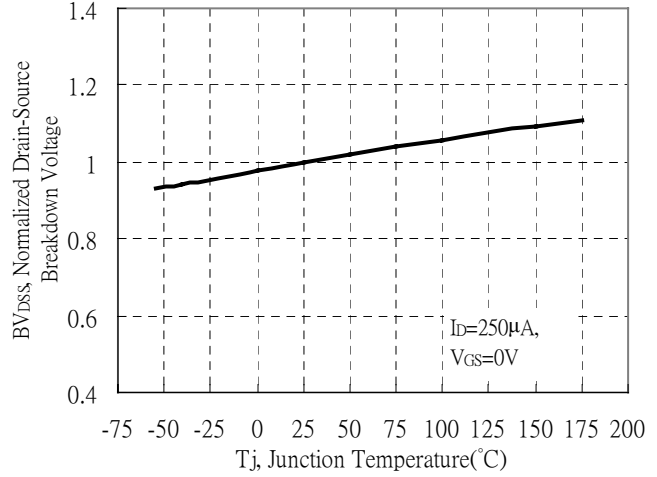

Static Drain-Source On-State resistance vs Drain Current

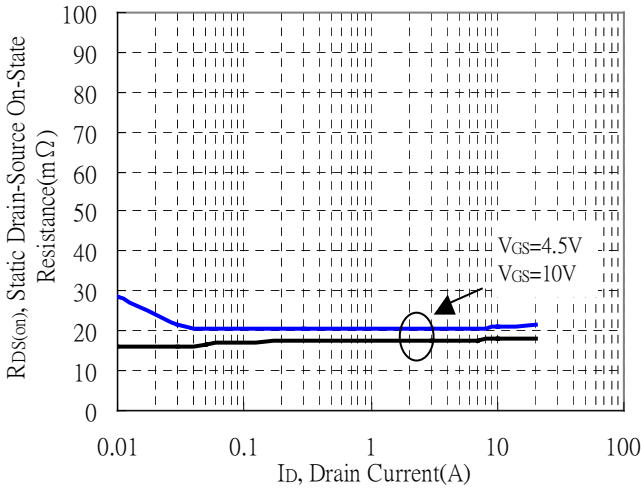

Reverse Drain Current vs Source-Drain Voltage

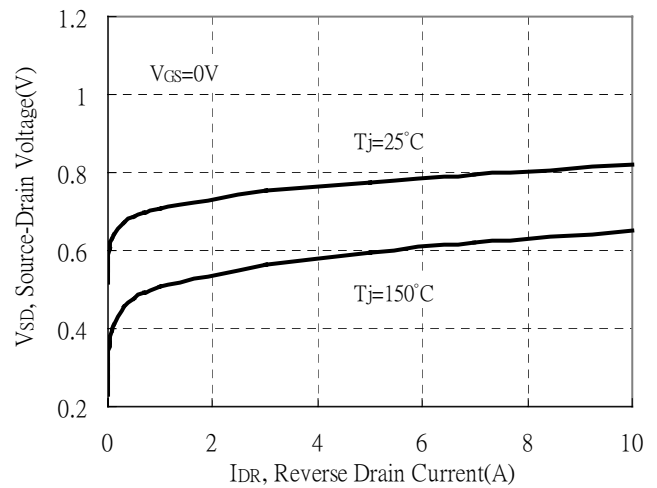

Static Drain-Source On-State Resistance vs Gate-Source Voltage

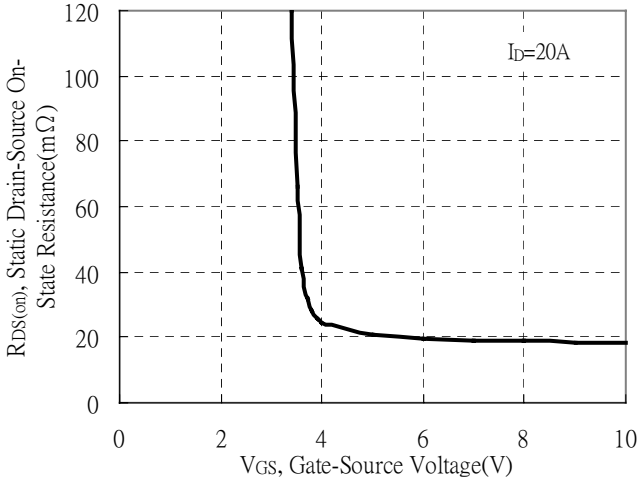

Drain-Source On-State Resistance vs Junction Temperature

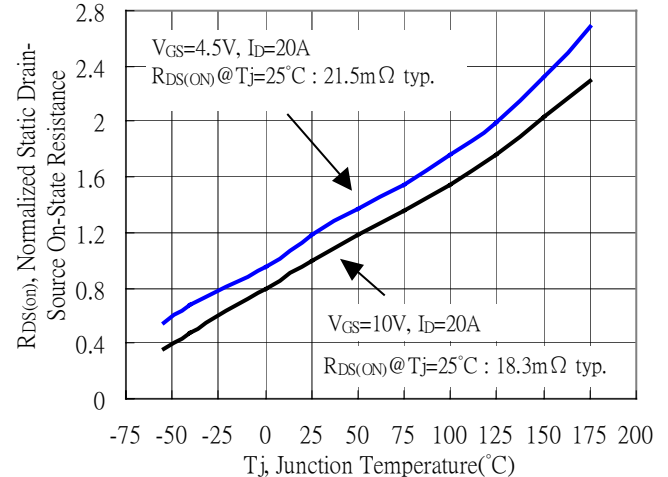



**Typical Characteristics(Cont.)**

Capacitance vs Drain-to-Source Voltage

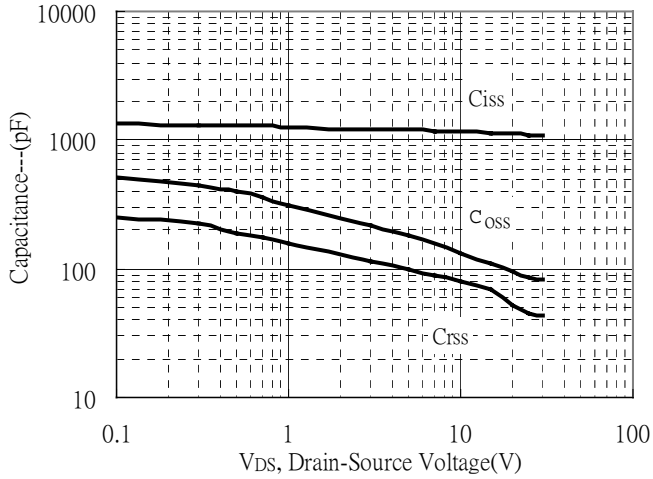

Threshold Voltage vs Junction Temperature

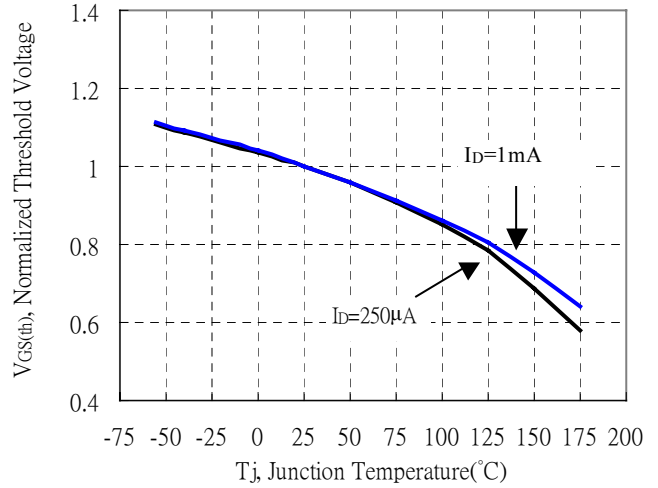

Forward Transfer Admittance vs Drain Current

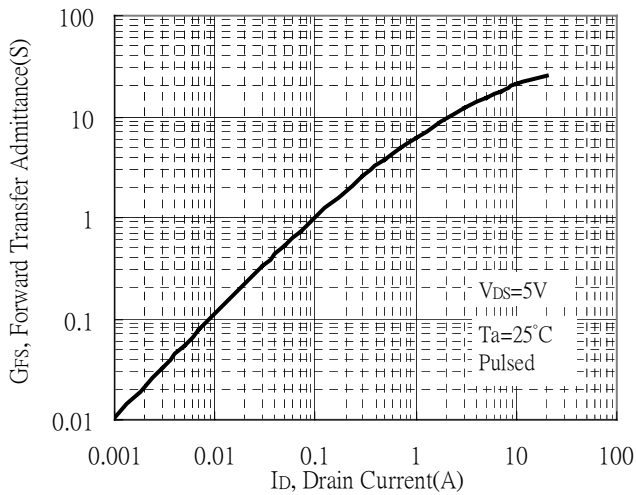

Gate Charge Characteristics

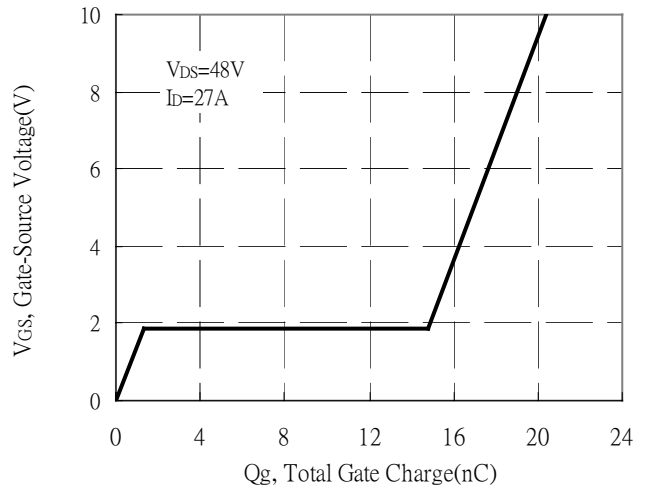

Maximum Safe Operating Area

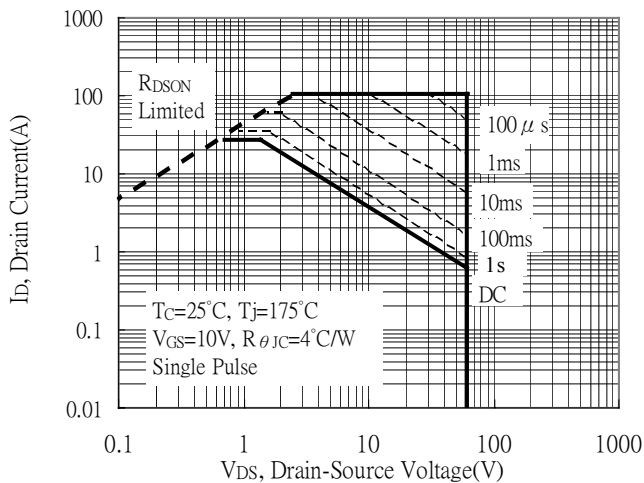

Maximum Drain Current vs Case Temperature

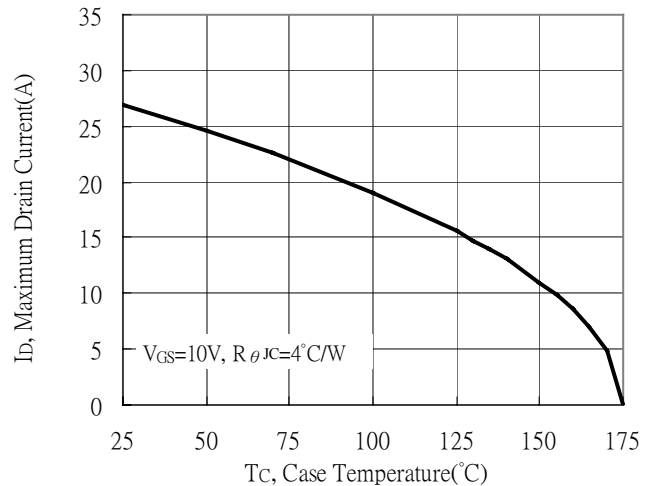

**Typical Characteristics(Cont.)**

Typical Transfer Characteristics

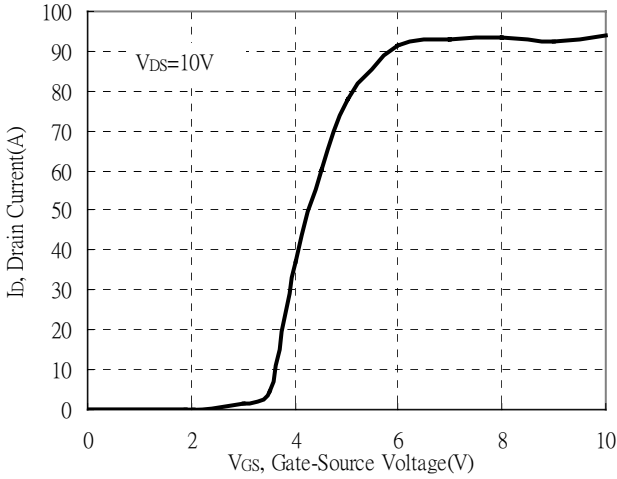

Single Pulse Power Rating, Junction to Case

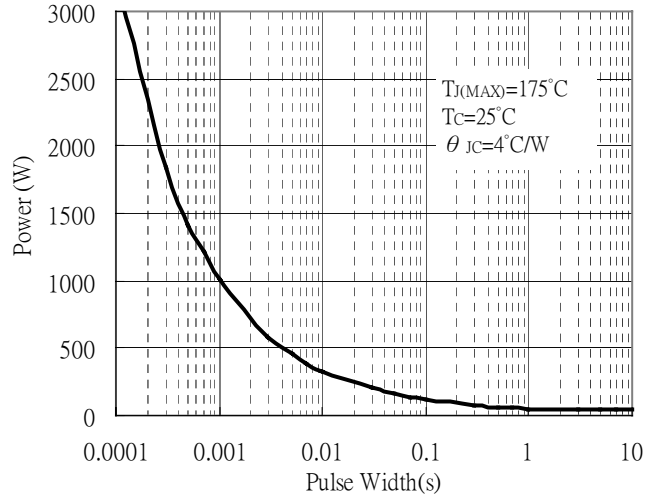

Transient Thermal Response Curves

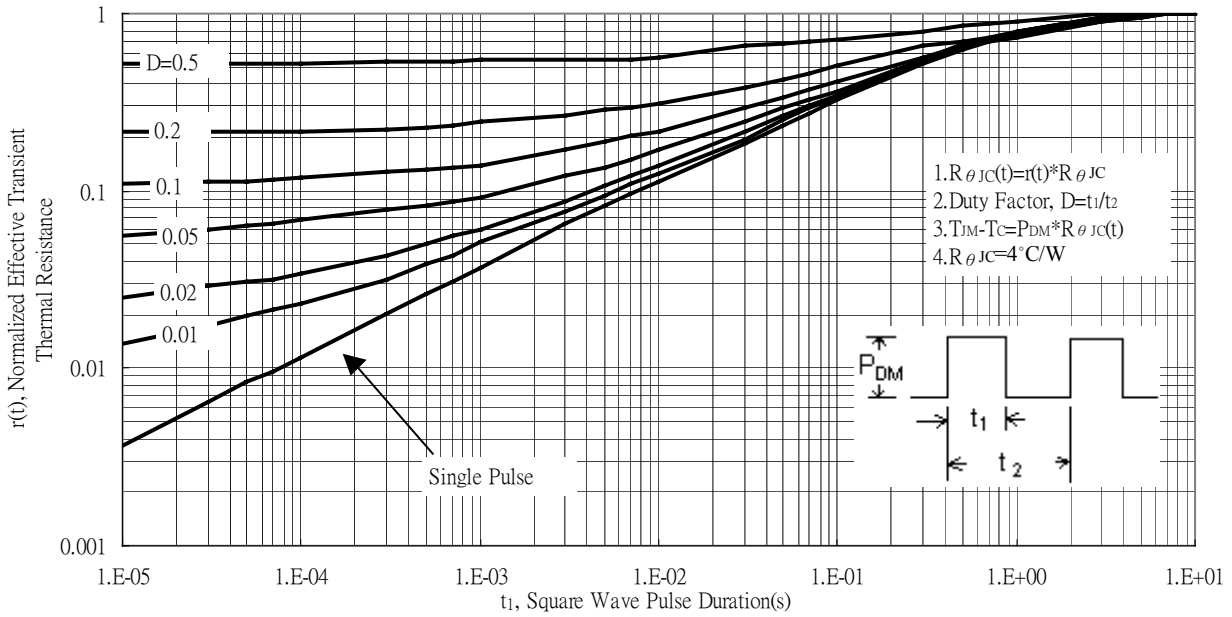

**Recommended wave soldering condition**

Product	Peak Temperature	Soldering Time
Pb-free devices	260 +0/-5 °C	5 +1/-1 seconds

**Recommended temperature profile for IR reflow**

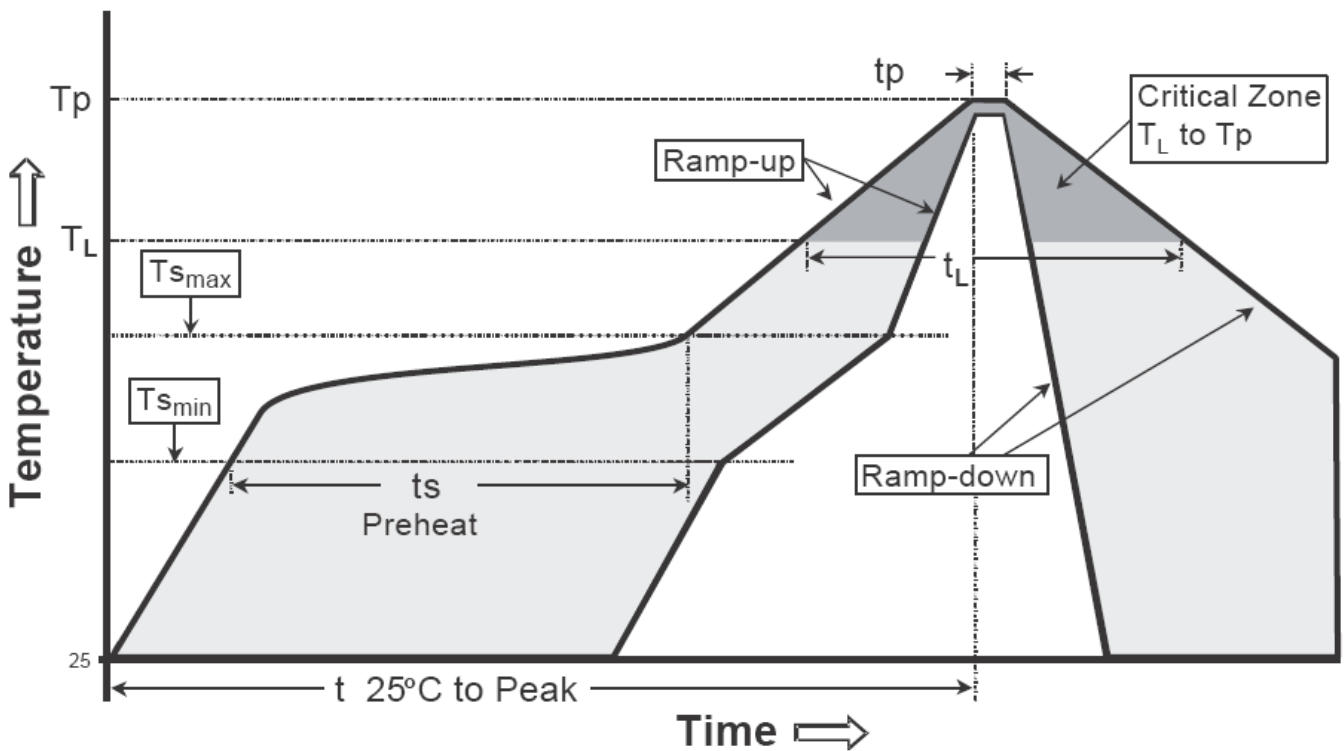

Profile feature	Sn-Pb eutectic Assembly	Pb-free Assembly
Average ramp-up rate (T <sub>smax</sub> to T <sub>p</sub> )	3°C/second max.	3°C/second max.
Preheat		
-Temperature Min(T <sub>s min</sub> )	100°C	150°C
-Temperature Max(T <sub>s max</sub> )	150°C	200°C
-Time(t <sub>s min</sub> to t <sub>s max</sub> )	60-120 seconds	60-180 seconds
Time maintained above:		
-Temperature (T <sub>L</sub> )	183°C	217°C
- Time (t <sub>L</sub> )	60-150 seconds	60-150 seconds
Peak Temperature(T <sub>P</sub> )	240 +0/-5 °C	260 +0/-5 °C
Time within 5°C of actual peak temperature(tp)	10-30 seconds	20-40 seconds
Ramp down rate	6°C/second max.	6°C/second max.
Time 25 °C to peak temperature	6 minutes max.	8 minutes max.

Note : All temperatures refer to topside of the package, measured on the package body surface.

**TO-220FP Dimension**

**3-Lead TO-220FP Plastic Package**  
 CYStek Package Code: FP

**Marking:**

Device Name → **B20**  
 N06  
 Date Code → □□□□

Style: Pin 1.Gate 2.Drain 3.Source

\*Typical

DIM	Inches		Millimeters		DIM	Inches		Millimeters	
	Min.	Max.	Min.	Max.		Min.	Max.	Min.	Max.
A	0.171	0.183	4.35	4.65	G	0.246	0.258	6.25	6.55
A1	0.051 REF		1.300 REF		H	0.138 REF		3.50 REF	
A2	0.112	0.124	2.85	3.15	H1	0.055 REF		1.40 REF	
A3	0.102	0.110	2.60	2.80	H2	0.256	0.272	6.50	6.90
b	0.020	0.030	0.50	0.75	J	0.031 REF		0.80 REF	
b1	0.031	0.041	0.80	1.05	K	0.020		0.50 REF	
b2	0.047 REF		1.20 REF		L	1.102	1.118	28.00	28.40
c	0.020	0.030	0.500	0.750	L1	0.043	0.051	1.10	1.30
D	0.396	0.404	10.06	10.26	L2	0.036	0.043	0.92	1.08
E	0.583	0.598	14.80	15.20	M	0.067 REF		1.70 REF	
e	0.100 *		2.54*		N	0.012 REF		0.30 REF	
F	0.106 REF		2.70 REF						

- Notes:**
- Controlling dimension: millimeters.
  - Maximum lead thickness includes lead finish thickness, and minimum lead thickness is the minimum thickness of base material.
  - If there is any question with packing specification or packing method, please contact your local CYStek sales office.

**Material:**

- Lead: Pure tin plated.
- Mold Compound: Epoxy resin family, flammability solid burning class: UL94V-0.

**Important Notice:**

- All rights are reserved. Reproduction in whole or in part is prohibited without the prior written approval of CYStek.
- CYStek reserves the right to make changes to its products without notice.
- CYStek **semiconductor products are not warranted to be suitable for use in Life-Support Applications, or systems.**
- CYStek assumes no liability for any consequence of customer product design, infringement of patents, or application assistance.